

CNET Hardware Reference Manual



16CHANNEL **DIGITAL INPUT** MODULE

cnDM16-00

MAR 2016
©2016 COMIZOA, All rights reserved

Hardware Manual Revision : 1.0.1
Revision Data 2016. 03. 04

Table Of Contents

1	개요	1
2	제품사양	2
3	Wiring	3
4	Device ID Setting	4
5	Indicators	4
6	C-NET Baud Rate Setting	4

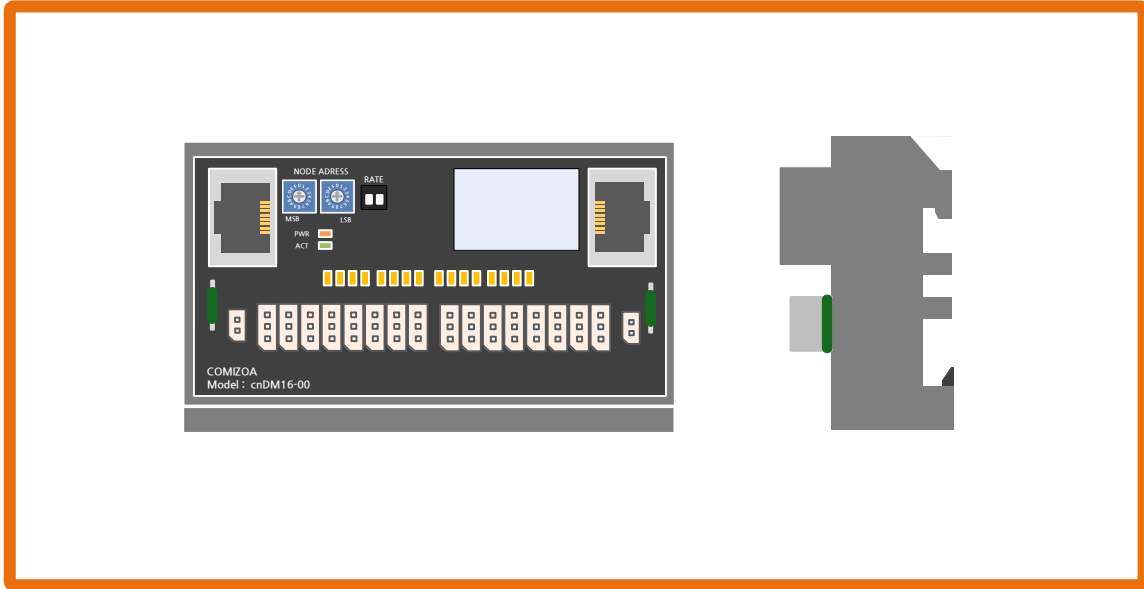
개요

CNET Series - cnDM16-00 (Digital NPN Input 16ch)

cnDM16-00은 커미조아의 CNET 기반 제어기의 16채널 Digital 입력 모듈입니다.
 각 채널의 내부 제어신호와 외부 입출력 신호는 포토커플러를 사용하여 절연됩니다.
 본 매뉴얼은 cnDM16-00의 하드웨어 구성과 기능에 대해 설명하는 하드웨어 매뉴얼입니다.
 CNET 시스템의 전반적인 내용은 CNET product System reference 매뉴얼을 참조 바랍니다.

제품사양
■ Digital Input Specification

ITEM	Details
Number of Inputs	Isolated 16 Input
Input type	Current sinking type (NPN)
Input Level Tolerant	Low (Min. 0V ~ Max 1.5V)
	High (Min. 5V ~ Max 24V)
Isolation	1000V Channel to Channel
Input Impedance	3.6 KOhm

■ Power Specification

ITEM	Details
Power Dissipation	120mA @ 24 V DC
Rated Input Voltage	24V DC (-15%/+20%, ripple ratio within 5%) EN 61131-2

■ Environmental Specification

ITEM	Details
Dimension	50 * 105 * 33 (mm)
Install	Industrial DIN rail
Operating Temperature Range	0°C ~ 50°C
Storage Temperature Range	-20°C ~ 80°C
Operating Humidity Range	5% ~ 90%RH, non-condensing
Storage Humidity Range	5% ~ 90%RH, non-condensing

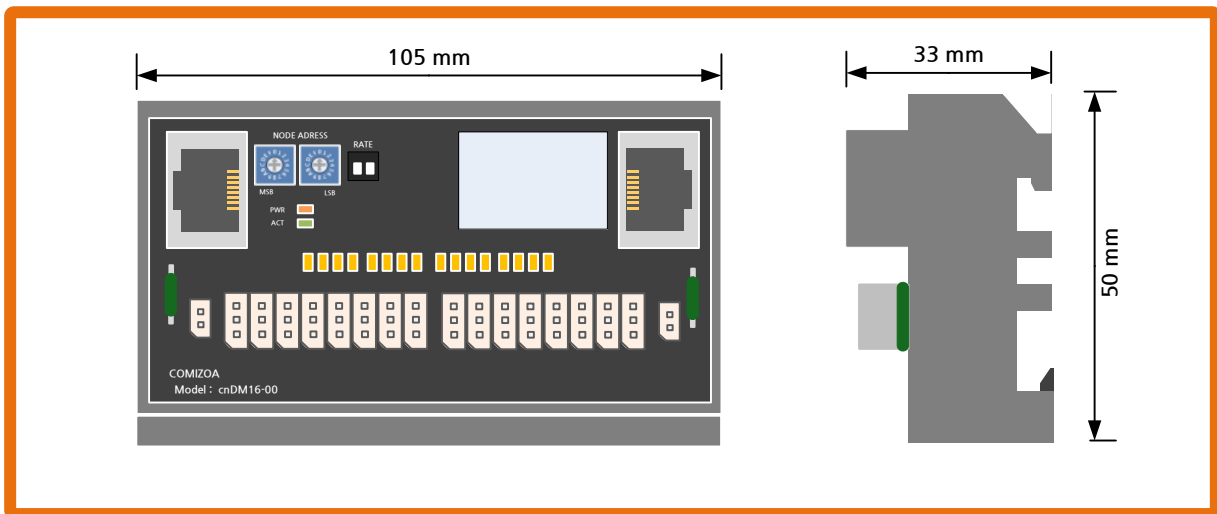

Dimension

Wiring

RJ45 Connector

P1		P2	
1	NC	1	NC
2	NC	2	NC
3	RS485_D+	3	RS485_D+
4	NC	4	NC
5	NC	5	NC
6	RS485_D-	6	RS485_D-
7	NC	7	NC
8	NC	8	NC

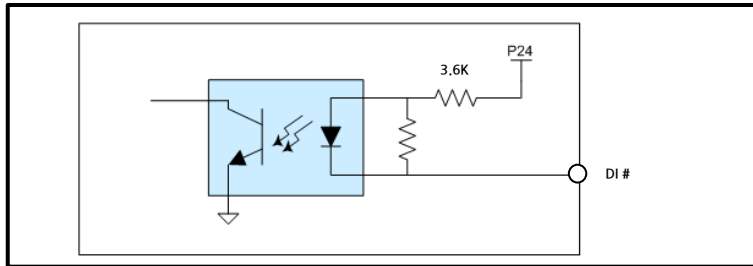
Circuit Diagram



PIN MAP

PWR 0, 1	
P	PWR 24V
N	PWR 0V

DI 0 ~ 15	
P	I/O PWR 24V
I	Digital Input
N	I/O PWR 0V

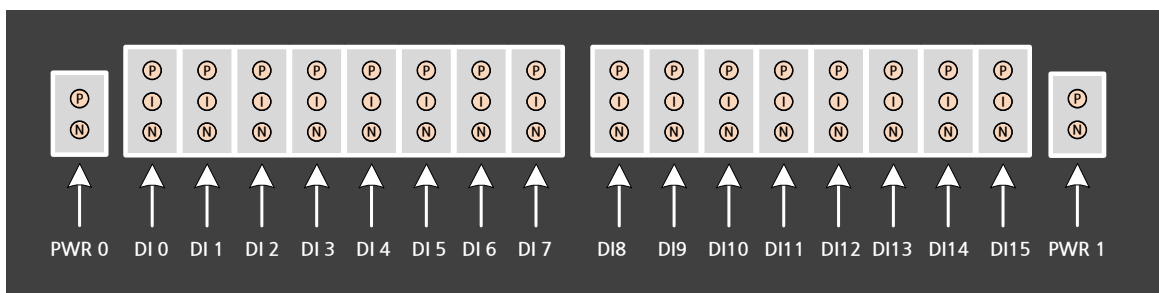

Device ID Setting

 MSB LSB	NODE ID setting	MSB(1:0) * 16 + LSB
	NODE ID range	0 ~ 63

Indicators

			
PWR	SYSTEM POWER LED	ON	SYSTEM POWER(3.3V DC) ON
		OFF	SYSTEM POWER(3.3V DC) OFF
ACT	C-NET STATE LED	ON	C-NET COMMUNICATION ACTIVATE
		OFF	C-NET COMMUNICATION DEACTIVATE

C-NET Baud Rate Setting

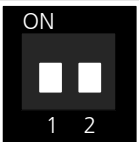
	11	2.5Mbps
	10	5Mbps
	01	10Mbps
	00	20Mbps

Hardware Reference Manual Update List

No.	Version	Date	Changes in
1			
2	1.01	2016.03.04	글꼴변경 (나눔고딕, 굴림)

CNET Reference Manual

Copyright holder : COMIZOA CO.,LTD
Copyright (c) by COMIZOA CO.,LTD. All right reserved.
2016. 03. 04.



COMIZOA CO.,LTD
<http://www.comizoa.com>
Tel) +82 - 42 - 936 - 6500
Fax) +82 - 42 - 936 - 6507

All the details including figures and programs included in this manual is protected by Korean Copyright.
Any parts of this manual can be copied or distributed without COMIZOA's permission.